



RWD68

Universal Controller

RWD68

For comfort control in HVAC & R-Systems

- Standalone electronic universal controller with P or PI response
- Operating voltage in accordance to type AC 24 V
- Control application selectable via Application Number
- Active input scale can be selectable
- Limit & direction of the output scale is able to be freely assigned
- Two universal inputs for Ni 1000, Pt 1000 temperature sensors & 0...10 V signals
- Unit can be set as °C, °F, % or no specified unit
- One modulating output with DC 0...10 V signal output, direct or reverse action
- One two-position output, direct or reverse action
- One digital input for day/night changeover
- Entering or changing of all data via operating buttons on the controller, possible without additional tools
- PC connection for downloading canned applications via the software tool

Use

The universal controllers are intended for Heating, Ventilating, Air-Conditioning and Refrigeration in comfort control plants. It can be mounted in a control panel or in the ARG62.21/ARG62.22 housing on ducts, walls and in plant rooms.

Measurement and control of temperature, relative humidity, absolute humidity, enthalpy, pressure differential, volumetric airflow and indoor air quality. The input scale can be set from –100 units to 8,000 units. The start and end points of output voltage can be any value between 0 V DC to 10 V DC.

Functions Summary

- Controller
Stand-alone controller with one direct or reverse acting DC 0...10 V output and one 2-position (ON/OFF) output with dependent and independent adjustment on each sequence for direct - or reverse acting. Adjustable parameters including proportional band and integral action time.
- Auxiliary selectable function
Universal input X2 for one of the following functions:
 - PI limiter function (absolute & relative)
 - Remote setpoint function
 - Cascade control function
 - Setpoint compensation
 - Winter/summer operation
 - Maximum priority
- Digital input D1 for setpoint changeover day/night

Input & Output summary

<i>Inputs</i>		<i>Outputs</i>		<i>Type</i>
Universal	Digital	Analog	Digital	Reference
2	1	1	1	RWD68

Accessories

<i>Name</i>	<i>Type</i>
Protective small enclosure for wall mounting	ARG62.21
Protective big enclosure for wall mounting	ARG62.22
Software Tool	S3341A031EN0

Equipment combinations

The following Landis & Staefa units can be connected to RWD68 universal controller.

<i>Units</i>	<i>Data sheet no.</i>
Sensor with LG Ni 1000 temperature sensing element	17... to 19...
Sensor with Pt 1000 temperature sensing element	1846
Sensor with DC 0...10 V measuring signal	17... to 19...
Room temperature sensor with setpoint adjuster QAA25 or QAA25/AP	1721 / 1748
Remote setpoint adjusters FZA21.11 + FZA61.11	19...
Air damper actuators with DC 0...10 V input	46...
Valve actuators with DC 0...10 V input	45...
Control valves	46...
Signal converter SEM 61.4 for current valve control	51...
Various signal converters	34...

Other combinations with third-party units are possible, provided the input and output specifications match the RWD68.

Software Tool

A software tool for controller application selection and parameter adjustment is available. It is a user-friendly Windows® 95 (or above) based software tool which provides you a printout of the controller settings.

Functions

Controller type

The RWD68 is a stand-alone universal controller which performs both primary and auxiliary control functions. The respective mode is defined by entering the corresponding configuration and setting parameters via the push buttons on the controller or the software tool.

Main functions

The RWD68 controller can be programmed as follows:

- One sequence: Q1 reverse or direct acting
- Two sequence: Y1 and Q1 reverse and direct acting or
Y1 and Q1 reverse and reverse acting (Independent and dependent control loop) or
Y1 and Q1 direct and direct acting (Independent and dependent control loop)

Reverse and/or Direct Acting

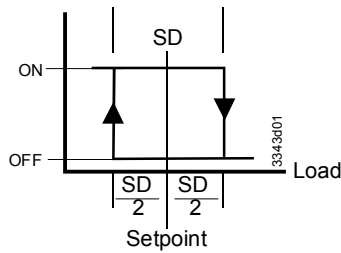

Reverse Acting Sequence
(Application No.: 10-19)

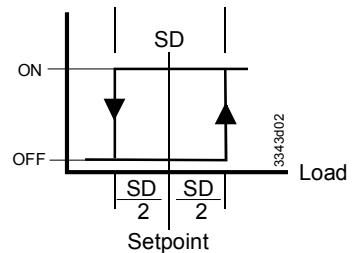

Direct Acting Sequences
(Application No.: 80-89)

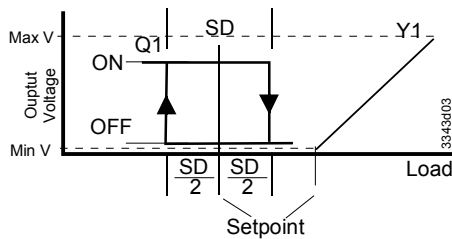

Reverse and Direct Acting Sequences
(Application No.: 40-49)

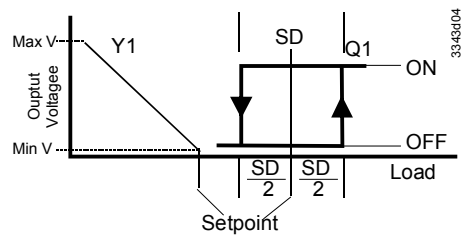

Reverse and Direct Acting Sequences
(Application No.: 50-59)

Reverse and Reverse Acting or Direct and Direct Acting

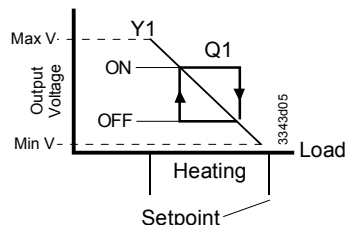

2 Reverse Acting Sequences
(Dependent control loop)
(Application No.: 20-29)

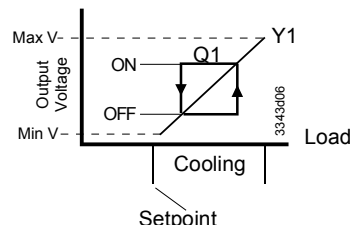

2 Direct Acting Sequences
(Dependent control loop)
(Application No.: 60-69)

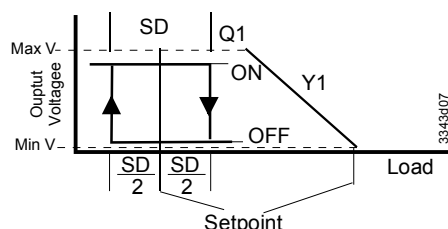

2 Reverse Acting Sequences
(Independent control loop)
(Application No.: 30-39)

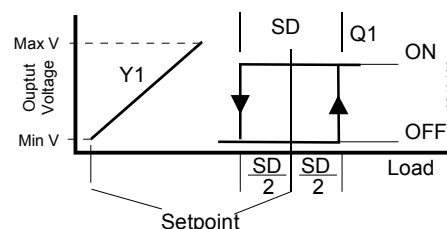

2 Direct Acting Sequences
(Independent control loop)
(Application No.: 70-79)

Universal input X1

The universal input X1 is used as the primary input for a Landis & Staefa Ni 1000 temperature sensor, a Pt 1000 temperature sensor or a 0...10 V DC active input.

Universal input X2

The universal input X2 is used as the secondary input for a Landis & Staefa Ni 1000 temperature sensor, a Pt 1000 temperature sensor, an active/passive remote setpoint transmitter or a 0...10 V DC active input.

Digital input D1

The digital input D1 is used to select the day/night changeover. Changeover occurs via potential-free contacts between D1 and M.

Analog output Y1

The output Y1 can be configured for either reverse or direct acting. The modulating voltage output (Y1) controls devices requiring a DC 0...10 V signal.

Digital output Q1

The output Q1 can be configured for either reverse or direct acting control.

Example

Ventilating plant with temperature control

X1 Room temperature
Q1 Heating, reverse action
Y1 Cooling, direct action

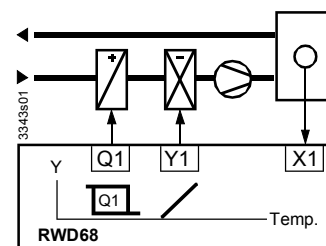

Auxiliary functions

One of the following auxiliary functions can be selected:

- PI limiter function (absolute & relative)
- Remote setpoint function
- Cascade control function
- Setpoint compensation
- Winter/summer operation
- Maximum priority

Additionally, the day and night operation mode is available.

PI limiter function

The limiter function with PI control enables absolute(or relative) maximum or minimum limitation of the supply air temperature (X2).
When the value drops below or exceeds the limiter setpoint, the limiter function controls and takes priority over the main setpoint.

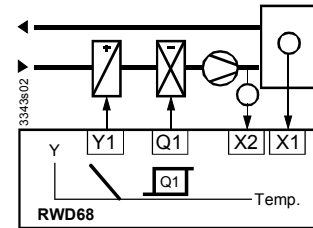

Remote setpoint

A remote setpoint transmitter (FZA21.11, QAA25 or QAA25/AP), connected to X2 and configured accordingly, enables setpoint adjustment.
Active measurement from 0...10 V DC corresponding adjustable range from -100 to 8000
Passive measurement from 0...1000 Ω corresponding adjustable range from -100 to 8000

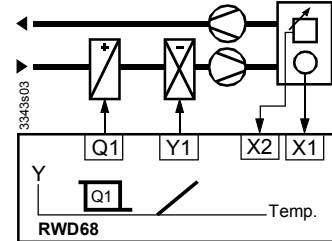

Cascade control

X2 Supply air temperature sensor
You can select the **PI/PI room/supply air temperature cascade control**. In this case, the virtual PI room temperature controller determines the setpoint within the limiter setpoints for the PI supply air temperature controller.

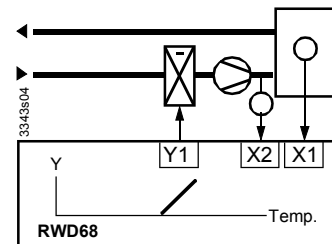

Maximum priority

Maximum priority, cooling
If the value (0...10 V) of the input X2 is greater than the calculated output of the cooling sequence, the output will use the X2 input value as output value. This is active even when the controller is working with the heating sequence.

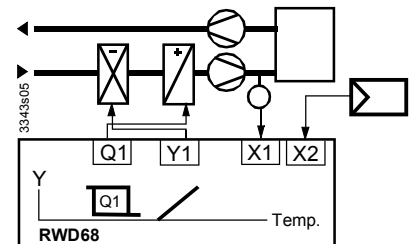

Setpoint compensation

The temperature setpoint X1 is shifted by the temperature as measured at sensor X2.
Configuration of the RWD68 defines the influence on setpoint X1.
The example shows the room air temperature setpoint as controlled by the outside temperature.

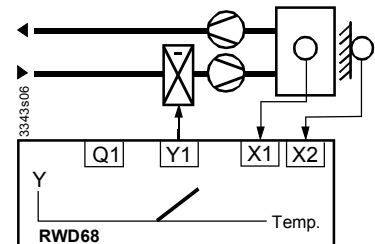

Winter/summer operation

A digital switch or analog input between terminals X2 and M can be used to implement winter/summer changeover.

Digital changeover

When the contact is closed, summer operation is selected. Reverse acting output is set to direct action (cooling).

Analog changeover

When the X2 input exceeds the setpoint, summer operation is selected. Reverse acting output is set to direct action (cooling).

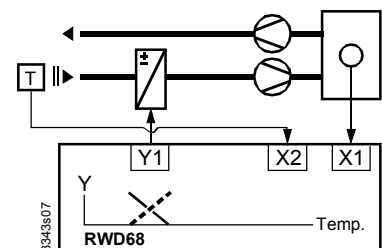

Note: The reverse acting output changeover occurs in Y1 only for application number 36, 37, 56 and 57, and in Q1 only for 16, 17, 46 and 47

Day/night setpoint

A contact between terminals D1 and M can be used to implement setpoint changeover for day/night operation.

When the contact is open, the setpoints for day operation are selected.

When the contact is closed, the setpoints for night operation are selected.

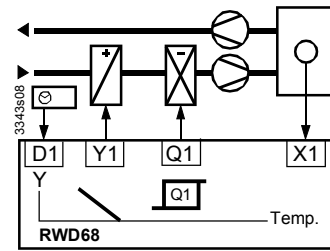

During the night mode, the following auxiliary functions are disabled: remote setpoint, absolute/relative limiter, setpoint compensation and maximum priority.

Mechanical design

Housing

The RWD68 universal controller is compact unit as per DIN 43 880 Gr. 1 requirements.

**Protective housing
ARG62.21/ARG62.22**

A protective housing is used to protect the controller when mounted outside a control panel, such as on ducts, walls and in plant rooms. Furthermore, the protective housing prevents inadvertent contact with voltage supplying parts such as the connecting terminals.

The RWD68 clips into the protective housing.

The cable entries are located at the top and the bottom of the protective housing. The front has an opening for the LCD display and the programming buttons.

Mounting options

The RWD68 universal controller can be mounted as follows:

- In a standard electrical control cabinet as per DIN 43 880
- Wall mounted in a protective housing
- Front mounting with standard available installation elements

Terminals

Plug-in screw terminals

Operating and display elements

The RWD68 is operated by the buttons on the controller front. Additional tools are not necessary. A 9-pin port is provided for optional programming via the software tool.

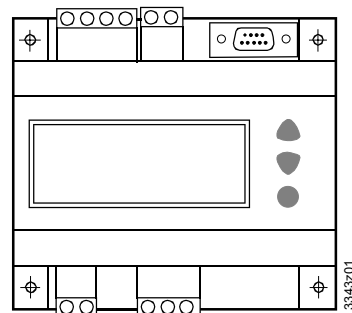

LCD

The LCD shows the following information for normal operation:

- Current operating values (maximum 4 digits)
- Current setpoints (day/night)
- Application number
- Output voltage value
- Control sequencing diagram
- Auxiliary input value
- Selected auxiliary function

Operating buttons

The controller has three operating buttons for the following functions:

SELECT ●

The SELECT ● button is used to enter or save the value adjustment.



The ▲▼ operating buttons are used for viewing and adjusting parameters.

Configuration

To configure the controller, follow the instructions supplied with the controller.

Engineering notes

Intended use

Use this controller only for applications as described in the description on the title page (bold print) and the section "Use". Additionally, observe all conditions and restrictions imposed in this section and in "Technical data".



The sections marked with a warning symbol contain technical safety requirements and restrictions. Observe all of these warnings as they directly relate to the protection of person and equipment.

Installation notes

The RWD68 controllers can be mounted as follows:

Observe all local installation and mounting regulations.

- A On a DIN rail (EN 50 022-35 x 7.5) at least 120 mm long
- B Wall mounted with 2 screws
- C Front mounted using standard elements
e.g. 1x DIN rail 150 mm long,
2 x hexagonal placeholders 50 mm, washers and screws
- D In the ARG62.21/ARG62.22 protective housing

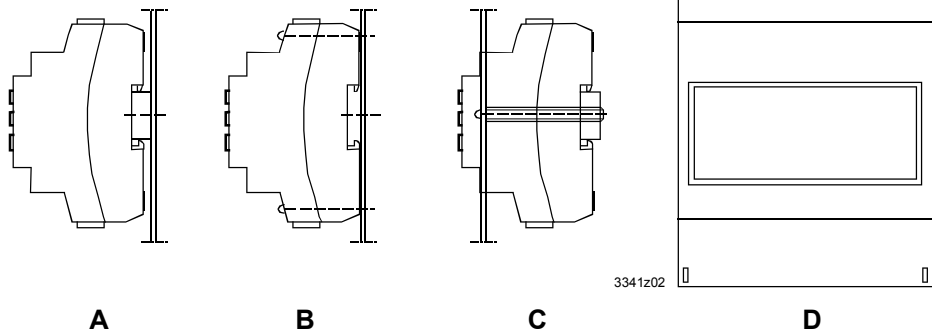

Electrical installation

Standard cables can be used for the controller. However, when mounting in an environment greatly exposed to EMI, use only shielded cables.



- The RWD68 is designed for AC 24 V operating voltage.

The low voltage must comply with the requirements for safety extra-low voltage (SELV) as per EN 60730.

Use safety insulating transformers with double insulation as per EN 60742; they must be designed for 100 % on-time.

When using several transformers in one system, the connection terminals G0 must be galvanically connected.

Supplying voltages above AC 24 V to low voltage connections may damage or destroy the controller or any other connected devices. Additionally, connections to voltages exceeding AC 42 V endanger personal safety.

Commissioning notes



A booklet is supplied with the RWD68 controller for commissioning.

Observe the following:

- The controller must be configured for plant-specific operation using standard application number.
- Plant specific fine tuning can be performed if required (refer to the commissioning booklet).
- Power supply to the controller and the connected devices must be guaranteed
- Values and settings entered remain available even on power failure.

Technical data

General data

 Power supply	Operating voltage	AC 24 V \pm 20 %
	Safety extra-low voltage (SELV) as per	EN 60730
	Frequency	50 Hz/60 Hz
Power consumption	RWD68	3.0 VA
LCD	Actual and nominal values	4 digits
Display resolution for (these values do not relate to the controller accuracy)	L&S Ni 1000 Ω	0.5 $^{\circ}$ C
	Pt 1000 Ω	0.5 $^{\circ}$ C
	Active sensor	Depends on the setting range
Environmental conditions	Transport	IEC721-3-2
	Climatic conditions	Class 2K3
	Temperature	-25...+70 $^{\circ}$ C
	Humidity	<95 % r.h.
Environmental conditions	Mechanical conditions	Class 2M2
	Operation	IEC721-3-3
	Climatic conditions	Class 3K5
	Temperature	0...+50 $^{\circ}$ C
IP code	Humidity	<95 % r.h.
	Housing	IP 20 as per EN 60529
	Front and with ARG62.21	IP 30 as per EN 60529
Product standards	Front and with ARG62.22	IP 30 as per EN 60529
	Automatic electrical controls for household and similar use	EN 60730
	 conformity	In accordance with European Union directives
	Electromagnetic compatibility EMC	89/336 EEC
	Low voltage directive	73/23 EEC
	Emissions	EN 50081-1
	Immunity	EN 50082-1
	Safety	EN 60730
Other international approval		 N474
Terminals	Screw terminals for cables with	min. 0.5 mm dia. max. 2 x 1.5 mm ² or 2.5 mm ²
Weight without packaging	RWD68	0.2875 kg

Analog inputs X1, X2

L&S Ni 1000 Ω at 0 °C	Controller measuring range Max. cable length for dia. 0.6 mm	-50...+150 °C max. 300 m
Pt 1000 Ω at 0 °C	Controller measuring range Max. cable length for dia. 0.6 mm	-20...+180 °C max. 300 m
Analog voltages (for measured variables in °C, % or without unit)	Range Max. cable length for dia. 0.6 mm	DC 0...10 V corresponding to adjustable range from -100 to 8000 (°C, °F, % or no unit) max. 300 m
Remote setpoints X2	Range Max. cable length for dia. 0.6 mm	0...1000 Ω corresponding to adjustable range from -100 to 8000 (°C, °F, % or no unit) max. 300 m
Digital input D1	Polling voltage for control commands (D...M) Current consumption	DC 15 V <15 mA
Analog outputs Y1, Y2	Range Maximum current	DC 0...10 V ± 1 mA
Digital output Q1	Relay contacts Voltage Maximum rating Minimum rating	AC 24...230 V AC 230 V, 4 A resistive, 3 A ind. (per relay terminal) DC 30 V, 4 A AC 19.2 V, 20 mA DC 5 V, 100 mA

Diagrams

Internal diagram

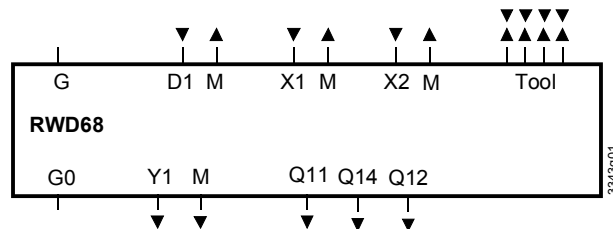

D1	Digital input
G, G0	AC 24 V supply ( SELV AC 24 V power supply)
M	Ground (G0) for signal inputs, universal inputs and analog outputs
Q1	Digital output, various voltages permissible AC 24...230 V
X1	Signal input (main input: LS Ni 1000, Pt 1000 and 0...10 V DC)
X2	Signal input (aux. input: LS Ni 1000, Pt 1000, 0 ...10 V DC and 0...1000 Ω or 0...10 V DC remote setpoint)
Y1	Analog output
Tool	Communication port for PC (9-pin plug)

Connection diagram

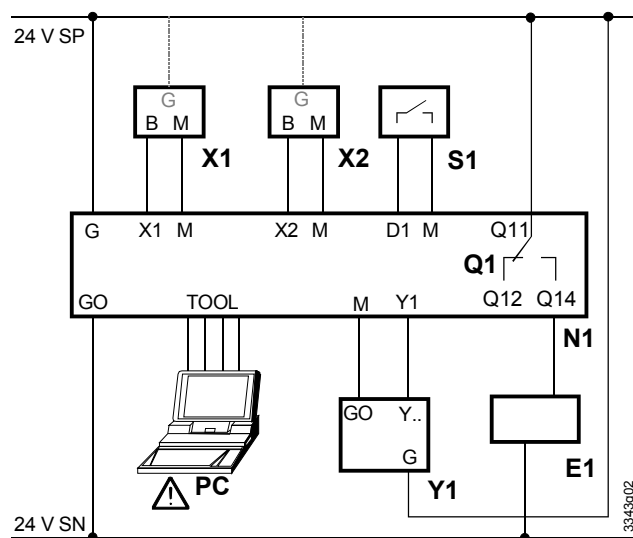

- E1 Electrical load
- N1 RWD68 controllers
- PC Personal computer
- Q1 Potential-free relay contacts for 2-position control
- S1 Time clock or switch
- X1 Main input (Termination G appears when X1 is an active sensor)
- X2 Auxiliary input or remote setpoint (Termination G appears when X2 is an active sensor)
- Y1 Valve actuator / damper actuator

Note



Please note that if you use a DESKTOP computer, the TOOL signal ground is galvanically connected to G0 inside the controller. If the signal line of the computer is grounded to Earth, the G0 line after TOOL connection will be Earthed as well. This will change from SELV to a PELV.

Dimensions

